

# **Weighing Indicator YH-T3**

**User Manual**

## Content

CHAPTER 1 MAIN SPECIFICATION .....	-2-
CHAPTER 2 INSTALLATION .....	- 3-
2.1 FRONT AND BACK VIEW OF INDICATOR .....	- 3-
2.2 CONNECTING LOAD CELL TO INDICATOR .....	- 4-
2.3 SERIAL COMMUNICATION INTERFACE (OPTIONAL) .....	- 4-
CHAPTER 3 OPERATION.....	- 5-
3.1 TURNING ON.....	- 5-
3.2 OPERATION.....	- 5-
CHAPTER 4 CALIBRATION.....	- 7-
CHAPTER 5 ERRORS INDICATION.....	-9-
CHAPTER 6 CHARGEABLE BATTERY.....	-9-
CHAPTER 7 MAINTENTANCE .....	-10-

## Chapter 1 Main Specification

### 1. Analog:

Input Signal: 0 ~ 10mV  
Converting Speed: 40 times/second  
A/D code: 360000  
Non-linearity: 0.03%  
Drift: 0.03%  
Stimulating Voltage: DC+5V  
Load Cell: 1 × 350Ω

### 2. Display

Display: 0 ~ 999999  
Interval: 1/2/5/10/20/50 (optional)

### 3. Serial Communication Interface (Optional)

Signal: RS232C  
Transmission Distance: < 20m

### 4. Ambient Environment

Power Supply: AC 220v ( ~15% ~ +10% ); 50HZ (-2% ~ +2%)  
Ambient Temperature: 0°C ~40°C  
Storing Temperature: -25°C ~55°C  
Ambient Temperature: ≤85%RH  
Warm-up Time: 10~15minutes  
Fuse: 500Ma

### 5. Weight: 2Kg ( excluding battery )

## Chapter 2 Installation

### 2.1 Front and back view of the Terminal

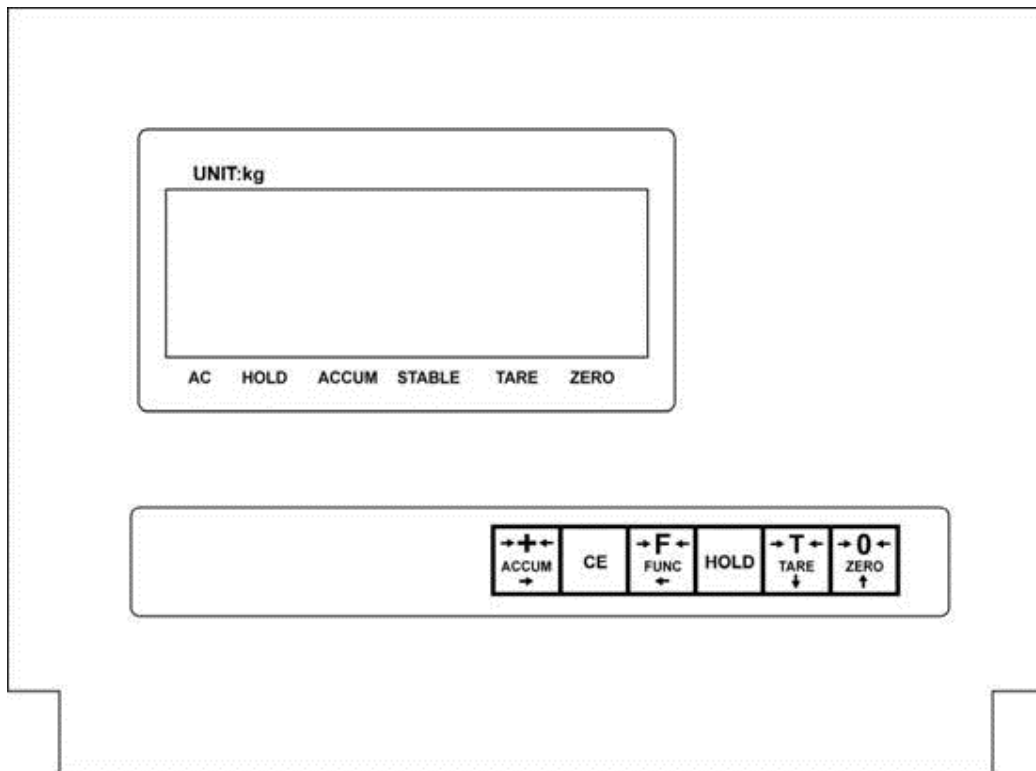

**Front View of the Terminal**

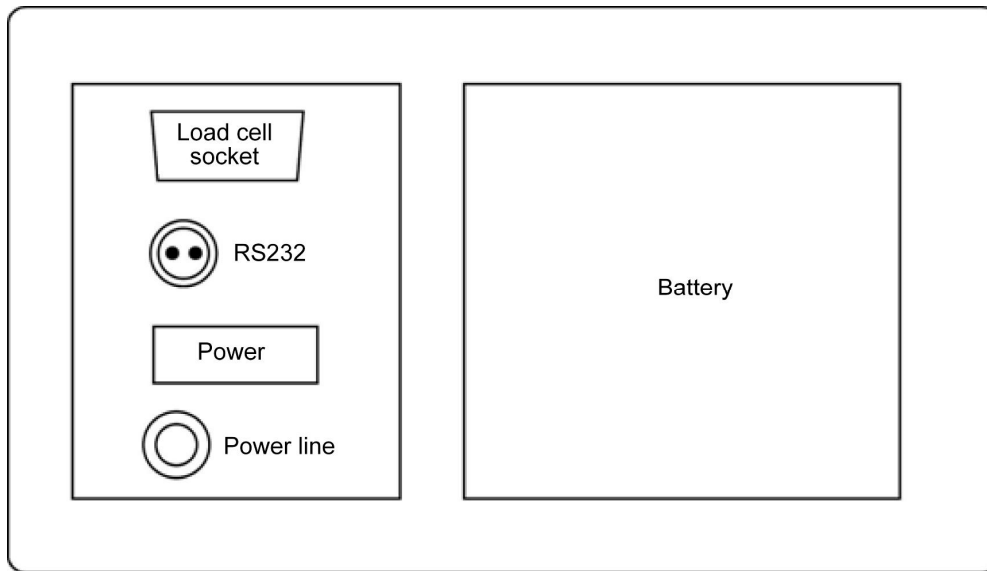

**Back View of the Terminal**

## 2.2 Connecting load cell to Terminal

The 9 pin plug is for load cell , please connects the line as following graphs

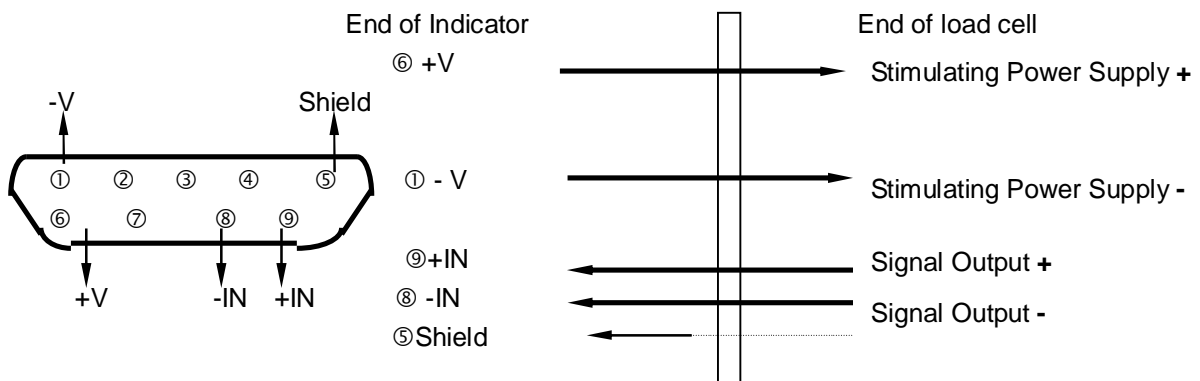

**Connection of load cell**

- ◆ You must cut off power when connecting load cell, the connection must be reliable.
- ◆ After connecting load cell, you should fasten plug with screw-driver.
- ◆ Load cell and Terminal are static sensitive devices, you must adopt anti-static measures during operation. You must mount lightning rod in thunderstorm frequently happening area.

## 2.3 Serial Communication Interface (Optional)

1. Terminal communicate with computer by serial communication interface .
2. Connection

Terminal communication interface adopts 5 pin plug, pin definition is as follows

5 pin -----TXD signal (serial communication data)

1 pin ----- ground line

2 pin ----- shield line

The communication interface is 2pin plug.

1 pin -----signal (serial communication line)

2 pin -----ground line for communication

### 3. Parameter

- ① Signal: RS232C
- ② Baud Rate: 1200/2400/4800/9600 (Ref. Chapter 4 Calibration)
- ③ Data format:= 〈Weight data (including decimal)〉 ,ASCII Code

The low bit is prior to high bit and symbol. Negative symbol is"-"; Positive symbol is "0".

For example: While Terminal displays -500.00Kg, serial output is 00.005-

While Terminal displays 500.00Kg, serial output is 00.0050

## Chapter 3 Operation

### 3.1 Turning on



3.1.1 Turn on the power, the Terminal performs self-checking and displays current voltage of battery and go into weighing mode.

### 3.2 Operation



#### 3.2.1

Press  for zero return, Terminal returns to zero within the zero range 4%FS. To make sure the stabilization light is on when zero operation.



#### 3.2.2

At weighing mode, press  to deduct displaying weight while it is positive and stabilization light is on. Terminal displays net weight "0", tare light is on, press  to deduct tare, tare light is off, indicator displays gross weigh.

#### 3.2.3

At weighing mode, press  to enlarge the resolution of weight to 10 times. Press  again to get back.

#### 3.2.4



At weighing mode, press  to lock the weight value. Holding light is on. The weight value will be hold even if you take object off or put it on. Press  again to get back

### 3.2.5 Manual accumulation

At weighing mode, while the weight value is large or equal to 20 counts and the value is stable , press  to perform manual accumulation operation. Meanwhile, Terminal first shows the total accumulating times (two steps) :[n=] (that means the times displaying), after 1 second later , it displays accumulating times [ \*\*\*\*\*]; and then to display the total value of accumulation (two step):[ totl =] (that means to display the total value of accumulation), after 1 second later, it displays accumulating value [\*\*\*\*\*], accumulating light is on.

**Note: the max. accumulation times are 99999 (under the condition of accumulating amount ≤999999); Prior to the delete operation , the accumulating amount is recorded even power off .**

### 3.2.6 Automatic accumulation



At weighing mode, press  +  together, Terminal performs automatic accumulation, and accumulating light flashes. At automatic accumulation mode, while the weight value is large or equal to 20 counts and the value keeps stable for 1-2 seconds, indicator performs one time automatic accumulation, displaying accumulation times and amount.

**Note: The accumulating amount is not recorded under automatic accumulating mode when power off.**

### 3.2.7

At weighing mode, press  to delete the accumulation times and amount.

### 3.2.8 Kg/lb diversion

At weighing mode, press  +  together, Terminal performs unit diversion; while the unit is lb, the final decimal of the displaying value is lighted.





Note: once you operate accumulating and fail to delete the accumulation amount at one of the unit, unit diverting is not allowed ,unless you delete the accumulation amount

### 3.2.9 preset tare

At weighing mode, press  +  together, Terminal performs tare presetting.

The procedure is as follows:









Step	Operation	display	Explanation
1		[ ***** ]	Weighing display

2	Press  + 	[P00000]	Remind to input preset tare
3	Input preset tare, eg "6000"	[ 6000]	Press  6 times to change the lowest digit to "6", and then press  3 times to set the value as "6000", and press  to confirm
4		[ ***** ]	Turn back to weighing mode, displaying the net weight of deducting tare

### 3.2.10 Automatic dormancy



Terminal keeps at stable mode for 2 minutes and no any operating and weighing, it will turn to automatic dormancy, meanwhile the final decimal is lighted. Any operating and weighing will arouse it to working mode.

### 3.3 At calibration and preset tare mode, some of the keys perform as follows



-  : perform "1" adding, press  to add "1" on the lowest digit .
-  : perform moving, press  to move the lowest digit to left.
-  : perform inputting, press  to input setting value to the indicator
-  : perform exiting, press  to exit calibration

## Chapter 4 Calibration











4.1 Turn on the Terminal and connect load cell correctly . the indicator warms up for 15-30 minutes at "no load"





At weighing mode, press  +  together for calibration

### 4.2 Calibration steps

Step	Operation	Display	Explanation
1		[ ***** ]	Weighing display
2	Press  + 	[ d * ]	Setting of interval: Terminal displays the original interval, which can be updated by operator
3	Input updated interval	[ d 1 ]	Parameter range:1,2,5,10,20,50,



	<p>Eg: "1"</p> <p>Press  once to change the value to "1"</p> <p>Press  for confirmation</p>		<p>Press  to confirm the updated one is as same as the original one</p>
4		[dP *]	<p>Decimal setting: Terminal displays the original decimal position, which can be updated by operator.</p>
5	<p>Input updated decimal Eg: "3"</p> <p>Press  three times to change the value to "3"</p> <p>Press  for confirmation</p>	[dP 3]	<p>Parameter range:0~5, 0 means no decimal, 1~5 separately means the decimal position from 1~5</p> <p>Press  to confirm the updated one is as same as the original one.</p>
6		[F *****]	<p>F.S setting: Terminal displays the original F.S., which can be updated by operator.</p>
7	<p>Input undated F.S. Eg:"6000"</p> <p>Press  six times to change the value to "6", and then press  three times to move to "6000", press  for confirmation</p>	[ 6000]	<p>If there is no need for zero and F.S calibration, press  to step 13, otherwise you must input F.S value to step 8 and 9.</p>
8		[ nloAd ]	<p>Zero calibration: Terminal self-checks the zero position, provided indicator didn't calibrated zero before, it displays the zero inner code, otherwise it go to step 9</p>
9		[ LoAd]	<p>F.S calibration: Zero position is confirmed, you can load weights for the preparation of F.S calibration, that should be <math>&gt; 1/2</math> of the F.S</p>
10	<p>Finish of weight loading, press</p>	[ *****]	<p>Terminal displays the inner code of the</p>

			loaded weight
11		[ ***** ]	At the stabilization of the value, Terminal will display the weight of loaded weight
12	Input the actual weight of loaded weight Eg: "3000"  Press  three times to change the value to "3", and press  for confirmation	[ 3000 ]	Press  to step 13, if the inputted weight is as same as the loaded weight.
13		[bt *]	Baud rate: Terminal displays the original baud rate parameter, which can be updated by operator
14		[ ***** ]	Calibration is over, exit to weighing mode

## Chapter 5 Error Indication

**ERROR0**

The zero inner code is over 260000 when calibration.

**ERROR1**

The loaded inner code is less ; load cell capacity is more .

**ERROR2**

The loaded inner code is more ; load cell capacity is less.

**ERROR 3**

Calibration exceeding

**HHHHHH**

The zero lever is too high or load on the platform .

**LLLLLL**

The zero lever is to high or no pan on the platform.

## Chapter 6 Chargeable Battery

6.1 Turing on the AC power, the Terminal will charge the battery automatically. So if you don't use

battery frequently, you should take battery out.

Note: red end is +, black end is -. Wrong connection will destroy Terminal.

Note: The built-in battery should be fully charged before it is used for the first time.

6.2 Only when you turn off the AC power, and push start key, battery works.

Displaying [LooL] means the insufficient of voltage, it needs charge.

6.3 When you use the battery first time, you should charge the battery for 20 hours in order to prevent low voltage resulted from the self leakage of the battery.

6.4 If you don't use battery for a long time, you should charge the battery for 10-12 hours for each 2 month to prolong using life of battery.

6.5 The battery is easily exhausted products. And it is not granted free guarantee.

## Chapter 7 Maintenance

7.1 To guarantee Terminal clarity and using life, the indicator shouldn't be placed directly under sunshine and should be set in the plain space.

7.2 The Terminal can't be placed into the place where the dust pollution and vibration are serious.

7.3 Load cell should connect with Terminal reliably, and the system should be well connected into ground. The Terminal must be protected from high electrical field and high magnetic field.

- ◆ In order to protect the operator, Terminal and relevant device, you should mount lightning rod in thunderstorm frequently happening area.
- ◆ Load cell and Terminal are static sensitive device, you must adopt anti static measures.

7.4 It is strictly forbidden to clean the case of Terminal with intensive solvents (for example: benzene and nitro oils)

7.5 Liquid and conducting particle should not be poured into the Terminal, otherwise the electronic components will be damaged and electric shock is likely to happen.

7.6 You should cut off power supply of Terminal and relevant device before you pull-in and out the connecting line of Terminal and external device.

- ◆ You must cut off power supply of Terminal, before pulling out connecting line of load cell.

7.7 During operation, if trouble occurs, operator must pull off the power supply plug immediately, and user should return this Terminal to our company for repair. Non-weighing manufacturer should not repair it, or by yourself, otherwise further destruction may happen.

7.8 The storage is not granted the free repair guarantee, because it is easily exhausted products.

- ◆ In order to prolong using life, please charge the cell fully before using it. If you don't use the Terminal for a long time, you must charge the cell every two month and for eight hours/each charging time.
- ◆ Moving or installation must be carefully taken and must avoid strong vibration, impact and bump in order to protect the storage cell from being damaged.

7.9 From invoice date, the Terminal has a one-year free repair period. If any non-artificially obstacle about the Terminal happens under correct using conditions within this period, the user is allowed to send the product with its guarantee card (of the correct number) back to our corporation for free repair. The Terminal shouldn't be taken apart, otherwise free guarantee will be cancelled.