

## Electronic Crane Scale



## User's Guide

### Table of Contents

1. Overview
2. Features & Specifications
3. Functions of Key Pad & Indicators
4. Basic Operations
  - Power ON
  - Initial on Zeroing
  - Manual Addition
  - Display of Total Weight
  - Set Parameters
  - Weighing
  - Power OFF
5. Battery Charging
6. Scale care
7. Calibration
8. Dimensioned Drawing of Scale
9. Instruction of Infrared Control
10. Optional Accessories

## 1. Overview

This series crane scale is a high-tech scale. The digital crane scale employs both the advanced hardware and sophisticated software. It uses AT-89 series single-chip micro-processor and highly precision A/D converter. In addition, the crane scale is equipped with specially designed compensating circuitry for rocking loads. With its quick stabilization and strong interference-rejection, it can be widely used in weighing applications in commerce, industrial and mining industries, and warehousing wharf, etc.

## 2. Features & Specifications

Accuracy Class	III
Initial on Zero Range	Selectable 0%、5%、10%、20%、50%、100% F.S
Time to Stable Static Reading	≤10 seconds
Maximum Safe Load	150% F.S.
Display Screen	Super bright 1.2" 5-digit LED display
Operating Temperature	-10 °C ~ +40°C
Operating Humidity	≤85%RH
LOB Indicator	When the power is low, the indicator will be on
Auto-OFF	The scale will shut off automatically once the power is severely low.
Recharging Protective Circuitry	To prolong the performing life of the battery
Cast Aluminum Housing	Rust protection, antistatic & light weight



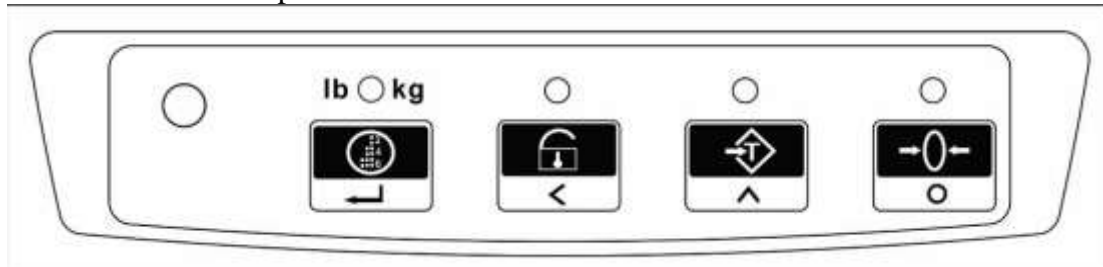

Max. Capacity (kg)	Mini. Weight(kg)	Measured Division	Selectable Division
600	4	0.2	0.1
1000	10	0.5	0.2
2000	20	1	0.5
3000	20	1	0.5
5000	40	2	1
10000	100	5	2
15000	100	5	2

### 3. Functions of Key Pad & Indicators

Presented below is the scale panel:

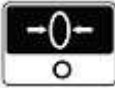

As presented on the panel, , , ,  are operating keys, of whose functions are in the following:

- a)  –Use this key to add the load weight. It is only usable when the scale is in manual mode of operation.
- b)  –Press this key to keep the current displaying weight and the  indicator will be on. Press the key again to turn off temporarily holding function. In the value input, press this key to add 1 and circulate in the 0 to 9.
- c)  – Press this key to tare and the  indicator will be on. Press the key again to turn off temporarily tare function.
- d)  – Press this key to zero the current displaying value.
- e) LB/KG- When the red light on it means the unit is on KG. When the light turn green, the unit is on LB

### 4. Basic Operations

#### 4.1 Power On

Turn on the power switch at the back of scale to the ON position. The scale will display the version number and then the maximum weight capacity individually for one second. Then the nixie light will display “99999”, “88888” ..... “00000” in turn. Then scale will undergo self-

check of reset sequence and indicators with LED indicators on and off alternatively and finally come into weighing mode.

#### 4.2 Initial on zeroing



After power on, the scale enters into weighing mode and then displays “0”kg. If it is not “0”kg, it’s normally caused by overloading the permitted value of the initial on zero range. In this case, please switch off the scale and re-start it and choose the desired parameter. (Please see initial on zero Range below.)

#### 4.3 Manual Addition

When the displaying value is over zero, with weight on the scale, pressing  key, the current weighing value will be added to the total weight if with valid parameter. (Please see 4.5 Set Parameters.) The scale will show “bXXXX” for about one second. Here, “b” means the total number of loads and “XXXX” indicates the total number of adding.





**Note:** No matter manual add or auto-add, please zero the displaying value before another manual adding. Here, the zeroing range includes 20 division value of the capacity. When the number of adding reaches 9999, it will display FULL which indicates full memory. In this case, please clear the memory according to “4.7 Clear” in the following.













#### 4.4 Display of Total Weight

When the displaying value is within the zeroing range, press key  to see the total number of adding and the total weight of loads. It will firstly display the total number of loads. For example, the scale shows “b0327” indicating 327 loads weighed so far. Press  again, it will display the four left-hand number of the added value. For instance, “H 108” indicates the left-hand number of the total weight is “108”. Press  for the third times, it will show the four right-hand number of the total weight. For your reference, “L 2896” indicates the right-hand number of the total weight is “2896”. Accordingly, the total weight of the loads is “1082896 kg”.

#### 4.5 Set Parameters

Press [  ] during self-check sequence from “99999” to “00000”

Function	Operation	Display	Remarks
Division	Press [  ] during self-check sequence from “99999” to “00000”	dS 1	0: Measured Division 1: Selectable Division Press [  ] to change.
Sets buzzer	Press [  ]	bEE 1	0: Disable 1: Enable Press [  ] to change.
Zero point drift	Press [  ]	to 1	0: Close 1: Activate

			Press [  ] to change.
switch off the scale mode	Press [  ]	oFF 2	<p>0: The scale will keep displaying.</p> <p>1: The displaying window will go into sleeping mode with stable weighing value for 30 minutes. It will be activated when the displaying value is unstable or press the [  ] key .</p> <p>2: The scale will keep working for 30 minutes with stable weighing value displayed and then power-off automatically. Press [  ] to change.</p>
Addition condition	Press [  ]	AS 1	<p>0: Adding allowed when unstable</p> <p>1: Adding not allowed when unstable</p> <p>Press [  ] to change.</p>
Sets units	Press [  ]	Unt 0	<p>0: kg</p> <p>1: lb</p> <p>Press [  ] to change.</p>
Initial on zero range Setup	Press [  ]	o 20	<p>percent of capacity</p> <p>Press [  ] to change.</p>
Clear	Press [  ]	CLEAR	<p>Press [  ] save clear Operation then quit.</p> <p>Press [  ] to quit without save.</p>

## 4.6 Weighing

During the weighing process, the weight is ready to be recorded when the stable weight result is shown and the STAB indicator is on. If there is tare involved, such as rope or container, weigh them first. Press  to apply tare. The display should now be “0.0kg”, the net weight. With no change to the tare, the loads weighed afterwards will be their net weights until the change of tare value or the scale is turned off.

## 4.7 Power Off

After the weighing operation, turn off the scale by using the power switch on the back of the scale.











## 5. Battery Charging

- 5.1 It adopts maintenance-free rechargeable battery (6V/4.5Ah) and smart charger (DC6V/1Ah).
- 5.2. Once the digits blink on the scale, it reminds the scale of low battery, The battery needs to be charged now. The scale, however, can continue to operate for about 5hours without charging.
- 5.3.After the digitals blink for several minutes without charging or there is no more power in the battery, the scale will be powered off automatically. It will take about 5 hours to fully charge the battery.
- 5.4 After battery charging, if there is no display, it indicates that either there is difficulty in battery charging or a damaged battery. Please contact supplier for repair or replacement.
- 5.5 To prolong the battery life, we suggest you charge the battery no less than once per week. If the scale needs not to be charged for long time, you should charge it no less than once per month. To avoid any damage to the battery, please charge it correctly. Additionally, we suggest you switch off the scale to short the charging time.

## 6. Scale Care

- 6.1 Do not overload the scale to prevent the damage to the force transducer inside the scale. It will alarm you with buzzer and display “OVER1” if overloaded.
- 6.2 If display “Err01”after power on the scale, indicates that it will influence the accuracy or the important parameters lost.
- 6.3 Please check the scale frequently to insure the safe use. The basic checking list is:
  - 6.3.1 Whether the screw has come loose
  - 6.3.2 Whether the hook or shackle or any other component is cracked or distorted
  - 6.3.3 If the mechanical components showing sign of metal fatigue or defects
  - 6.3.4 Whether the pin is off or the components are lost.If there is any sign of the mentioned condition, please send the scale or components back to the manufacturer for repair or exchange before using the scale again.
- 6.4 Avoid any impact to the display panel.
- 6.5 Do not use the scale under wet or heavily polluted conditions.

## 7. Calibration

Steps	Operation	Display	Remarks
1	Hold on  to power on the scale	00000	1 <sup>st</sup> step of calibration. Password is required.
2	Press  to select the desired number, press  to shift digit	*****	***** is the password
3	After entering password, press 	SPAN	There should be no load on the scale
4	Press 	9500	9500 is the encode at zeroing loading
5	Press 	00000	Wait until the codes become stabilized and press [ADD/INPUT]
6	Press  to change to the desired number for the standard weight, press  to shift digits	03000	03000 is the standard weight of 3000kg to be loaded.
7	After the standard weight is loaded, press 	77683	77683 is the encode number of standard weight - 3000kg.
8	Press 	3000	Calibration is completed. The scale is in weighing mode. The current weight load is displayed.

Note: 1. Please make sure to wait until the encode is stabilized then press . Or it will lead to incorrect weighing results.

2. Do not calibrate the scale without standard weight.



### 8. Dimensioned Drawing of Scale

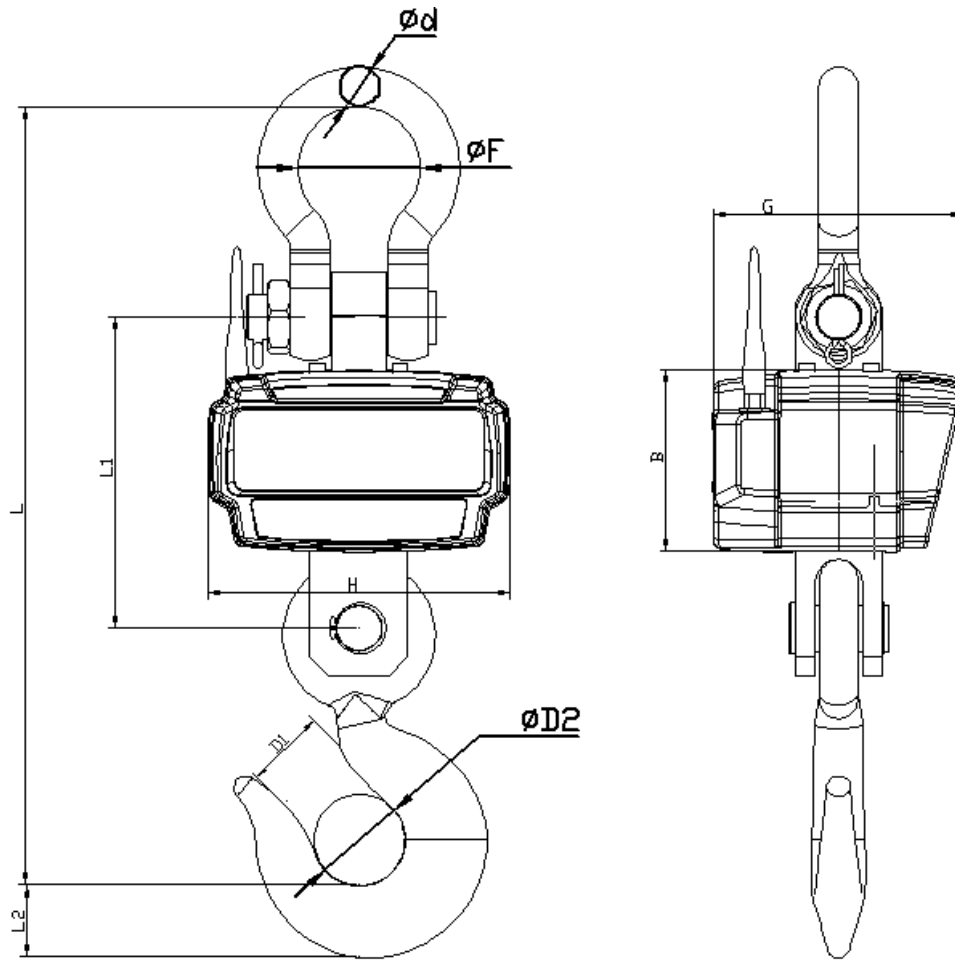

Model	B	G	H	L	L1	L2	D1	Φ2	Φd	ΦF
XZ-06JJE	120	163	198	420	190	33	40	47	21	76
XZ-1JJE	120	163	198	420	190	33	40	47	21	76
XZ-2 JJE	120	163	198	420	190	33	50	47	21	76
XZ-3 JJE	120	163	198	462	196	40	50	50	23	76
XZ-5 JJE	120	163	198	511	204	47	52	60	26	80
XZ-10 JJE	135	181	206	589	239	66	52	70	36	90
XZ-15 JJE	135	181	206	727	257	77	60	85	47	135

## 9. Instruction of Infrared Controller

Remote Control & Usage is the same with the scale body button.  
(the controller powered by AAA battery)

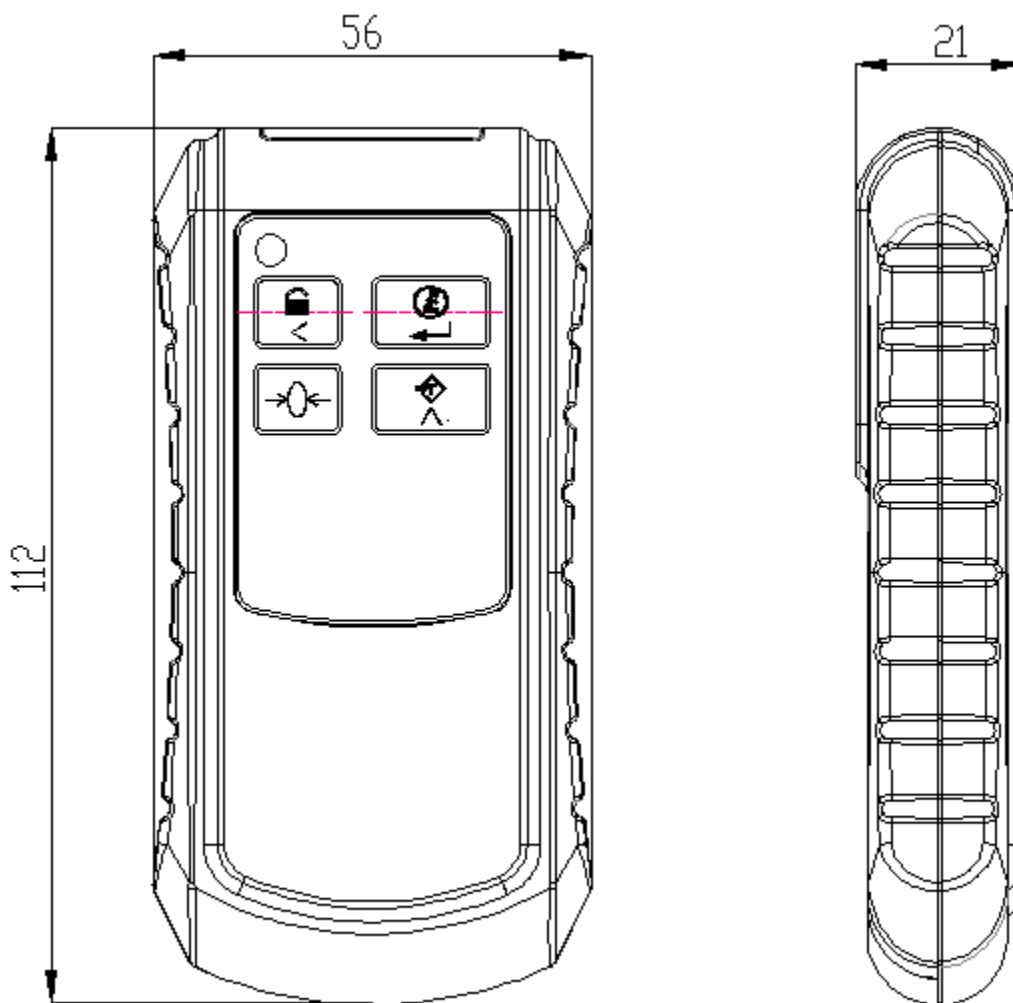

## 10. Optional Accessories

The scale could match one kind of our palm indicator after assembled the wireless A/D.

★ The products are subject to change without notice.