

Semi-Micro Analytical Balances

# GR Series



*Ergonomic, space-saving design  
with easy access door*

**AND**  
A&D Company, Ltd.

Discover Precision

<http://www.aandd.jp>

# Superb “New Generation” Analysis!

## Speedy & Simple Operation to Maximize Performance

### Easy Access Door

A unique system allows the user to conveniently open or close the left or right side of the weighing chamber using a control lever.

This system allows quick and efficient access to the weighing chamber.



Open left or right side from front

### One Touch Calibration

Allows quick calibration with one push of the CAL key.

### Automatic Adjustable Environment Setting

Adapts automatically to the most suitable Environment Response Setting to minimize adverse external effects. “FAST”, “MID” or “SLOW” is displayed.



### Automatic Self Calibration

Performs self calibration automatically when a change of ambient temperature exceeds the preset temperature range.



### 13 Multiple Weighing Units

g, mg, pcs, %, oz, ozt, ct, mom, dwt, GN, tl, t (tola), m (messghal)

### Two Layer Housing

Durable construction minimizes negative effects of ambient temperature changes.

### Splash Proof Keyboard and Display

Protected from dust and spills.

### Data Memory Function

Stores up to 200 sets of weighing data. Data can be output using numerical codes.



### GLP/GMP Compliant

Allows GLP or LIMS balance management by outputting the Balance ID number and weight used to calibrate the balance. The data can be output to A&D's AD-8127 printer or a computer, indicating date, time, Balance ID number and calibration weight.



```
A & D
MODEL GR-202
S/N 14221261
ID ABCDEFB
DATE 2018/09/25
TIME 12:34:56
CALIBRATED(INT.)
SIGNATURE
```

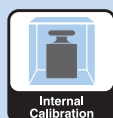

Internal Calibration



LCD Display

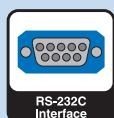

RS-232C Interface



GLP Compliant



Data Memory Function



Counting with ACAI



Percentage Function



Auto Power ON



Underhook



EC Type Approval



Software

# Space-Saving Design



The GR Series has a 30% smaller footprint compared with conventional balances.

Its tall weighing chamber can accommodate large beakers. The glass panes disappear into the back when opening the door, requiring no extra space at the rear of the balance.



## Underhook

Ideal for density measurement and weighing magnetic substances

## RS-232C Interface

Enables bi-directional communication with a PC or printer.

## Quick Reference Card

A fast and convenient operation guide.

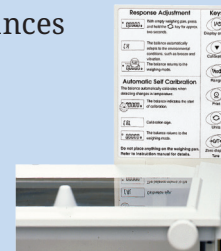

## WinCT–Window Communication Tools

WinCT is Windows Communication Tools Software, providing easy transmission of weighing data from A&D Balances to a PC using RS-232C interface.

Data can be transferred in a manageable format limited only by a PC's capability.

### WinCT consists of three applications:

**RsKey** allows weighing data to be directly pasted into a Windows application such as Microsoft Excel or Word, but this application cannot use “commands” to control the balance.

**RsCom** can transmit weighing data to a PC using a text file format and can transmit “commands” to control the balance. “Commands” include Calibrate, On/Off, Print, Query weight data, Re-zero, Range, Sample, Mode and Zero.

**RsWeight** can retrieve weighing data from a balance and display it in graph form on a PC screen in real-time. Maximum, minimum, average, standard deviation and coefficient of variation values of data can be calculated and displayed.



GR Series

RS-232C  
(Standard)

Cable : AX-KO1710

\* For a PC with no serial (RS-232C) port, please use the separately-sold AX-USB-25P serial/USB converter and cable set.

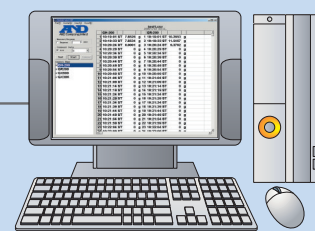

Win CT

RsCom, RsKey and RsWeight offer user selectable time, date, sequential #, interval transmission and GLP/GMP data. A readme file contains all setup, operation & troubleshooting guides.



## Specifications

	GR-202	GR-300	GR-200	GR-120
Weighing capacity	42 g / 210 g	310 g	210 g	120 g
Minimum weighing value	0.01 mg / 0.1 mg		0.1 mg	
Percentage Min Div.	0.01%			
Counting Min Weight	0.1mg			
Linearity	±0.0002 / ±0.00003g	±0.0003g	±0.0002g	
Repeatability/Std. Dev.	0.0001 / 0.00002g	0.0002g	0.0001g	
Stabilization Time	3.5 / 8 seconds (typically)		3.5 seconds (typically)	
Sensitivity Drift	±2ppm / °C (10°C~30°C / 50°F~86°F)			
Display Refresh	5 times per second / 10 times per second			
Pan Size	Ø85mm / 3.3inches			
Physical Dimensions	mm	249 (W) × 330 (D) × 328 (H)		
	inches	9.8 (W) × 12.99 (D) × 12.91 (H)		
Breeze Break Dimensions	mm	178 (W) × 160 (D) × 233 (H)		
	inches	7.01 (W) × 6.5 (D) × 9.17 (H)		
Admissible Ambient Conditions	5°C~40°C / 41°F~104°F RH less than 85%			
Weight Approximately	6.0kg / 13.2lb			
Power	Approx. 11VA (supplied to the AC adapter)			
Standard Accessories	Instruction manual, AC Adapter, Reference Card			

Specifications are subject to change for improvement without notice

## Accessories

AD-1653	Density determination kit
AD-1682	Rechargeable battery unit
AD-1683	Static eliminator
AD-1684A	Electrostatic fieldmeter
AD-1687	Weighing environment logger
AD-1688	Weighing data logger
AD-1689	Tweezers for calibration weight
AD-8127	Compact printer
AD-8526	Serial/Ethernet converter with WinCT-Plus
AD-8527	Quick USB adapter
AD-8920A	Remote display
AD-8922A	Remote controller
AX-USB-25P	Serial/USB converter and cable set

## Dimensions (mm/inches)

TOP VIEW

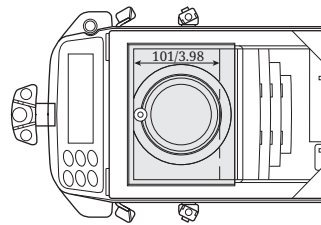

REAR VIEW

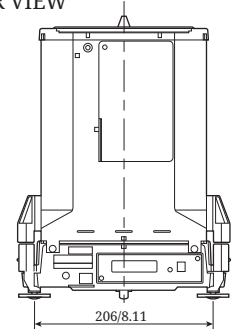

FRONT VIEW

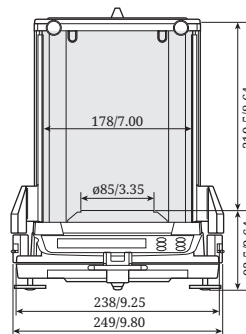

SIDE VIEW

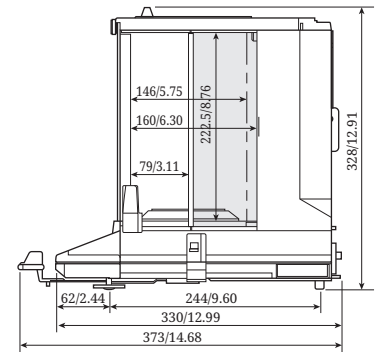

## AD-1653 Density Determination Kit



**AND**  
A&D Company, Ltd.

## Discover Precision

### A&D Company, Ltd.

3-23-14 Higashi-Ikebukuro, Toshima-Ku, Tokyo, 170-0013, Japan Tel: +81 3-5391-6132 Fax: +81 3-5391-1566 <http://www.aandd.jp>

### A&D Engineering, Inc.

1756 Automation Parkway, San Jose, CA 95131, U.S.A. Tel: +1 408-263-5333 Fax: +1 408-263-0119

### A&D Australasia Pty Ltd.

32 Dew Street, Thebarton, South Australia 5031, Australia Tel: +61 8-8301-8100 Fax: +61 8-8352-7409

### A&D Instruments Ltd.

Unit 24/26 Blacklands Way, Abingdon Business Park, Abingdon, Oxfordshire, OX14 1DY, United Kingdom Tel: +44 1235-550420 Fax: +44 1235-550485

### <German Sales Office>

Hamburger Straße 30, D-22926, Ahrensburg, Germany Tel: +49 4102-459230 Fax: +49 4102-459231

### A&D Korea Ltd.

8F Manhattan Bldg., 33, Gukjegeumyung-ro 6-gil, Yeongdeungpo-gu, Seoul, 07331, Korea Tel: +82 2-780-4101 Fax: +82 2-782-4280

### A&D Rus Co., Ltd.

Vereyskaya Str. 17, 121357, Moscow, Russia Tel: +7 495-937-33-44 Fax: +7 495-937-55-66

### A&D Instruments India (P) Ltd.

509 Udyog Vihar Phase V Gurgaon-122 016, Haryana, India Tel: +91 (124) 471-5555 Fax: +91 (124) 471-5599