



Short Description



- Stainless steel IP67 shear beam load cell (250kg is bending beam load cells)
- Suitable for floor scales, platform scales, hopper and tank scales, patient lifts, etc.
- Current calibrated (sc-option)



Test certificate no. TC8010 Revision 0 and D09-05.19

C of C no R60/2000-NL1-11.28 and R60/2000-CN1-06.05



Certificate no. 12-022

Available Models

Capacity	Accuracy	Full Article Description
250kg	C3/C4/C5	B8D-C3/C4/C5-250kg-6B
500kg	C3/C4/C5	B8D-C3/C4/C5-500kg-6B
1t	C3	B8D-C3-1t-6B
2t	C3	B8D-C3-2t-6B
5t	C3	B8D-C3-5t-6B

Technical Specifications B8D

Accuracy Class		OIML R60 C3			OIML R60 C4	OIML R60 C5
Output Sensitivity (= FS)	mV/V	3.0 ± 0.008				
Maximum Capacity (E _{max})	t	0.25	0.5, 1, 2	5	0.25, 0.5	
Max. Number of Load Cell Intervals	n _{LC}	3000			4000	5000
Ratio of min. LC Verification Interval	Y = E _{max} / V _{min}	10000	7500	9000	10000	10000
Combined Error	%FS	≤± 0.023			≤± 0.018	≤± 0.014
Creep Error (30 minutes)	%FS	≤± 0.016			≤± 0.012	≤± 0.012
Temperature Effect on Zero (ZTC)	%FS/10°C	≤± 0.015			≤± 0.010	≤± 0.014
Temperature Effect on Sensitivity (STC)	%FS/10°C	≤± 0.011			≤± 0.009	≤± 0.007
Zero Balance	%FS	≤± 1.0				
Safe Overload	%FS	150				
Ultimate Overload	%FS	300				
Maximum Deflection	mm	~0.2 – 0.3				
Excitation, Recommended Voltage	V	5 ~ 12				
Excitation, Maximum Voltage	V	18				
Input Resistance	Ω	350 ± 3.5				
Output Resistance	Ω	350 ± 3.5				
Insulation Resistance (50V)	MΩ	≥5000				
Compensated Temperature	°C	-10 ~ + 40				
Operating Temperature	°C	-35 ~ + 70				
Load Cell Weight	kg	0.25t – 2t: 0.9 ~ 1.1			5t: 1.6	
Element Material		Stainless Steel				
Ingress Protection (acc. to EN 60529)		IP67				
Recommended Torque on Fixation Bolts	Nm	M12: 75			M20:450	
ATEX Classification (optional)		II 1G Ex ia IIC T4 Ga		II 1D Ex ia IIIC T ₂₀₀ 135°C Da		II 3G Ex ic IIC T4 Gc

Wiring

Features:

Cable type: Shielded, 4 conductor cable , conductor AWG 22
 Cable diameter: Ø 5.0mm
 Cable length: 6m
 Cable jacket: Polyurethane
 Shield not connected to element

4-Wire Connection Diagram

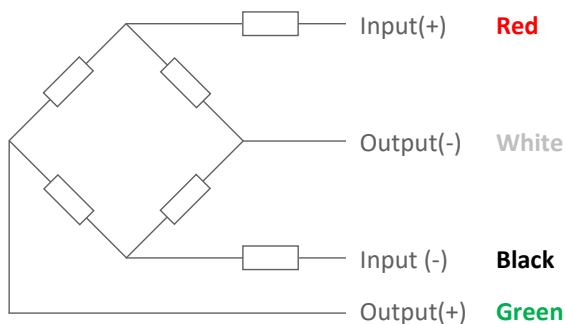

Specifications and dimensions are subject to change without notice and do not constitute any liability whatsoever.

Dimensions in mm

250kg Top View

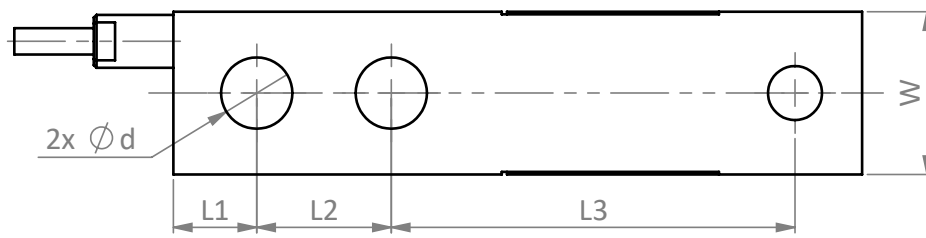

250kg Side View

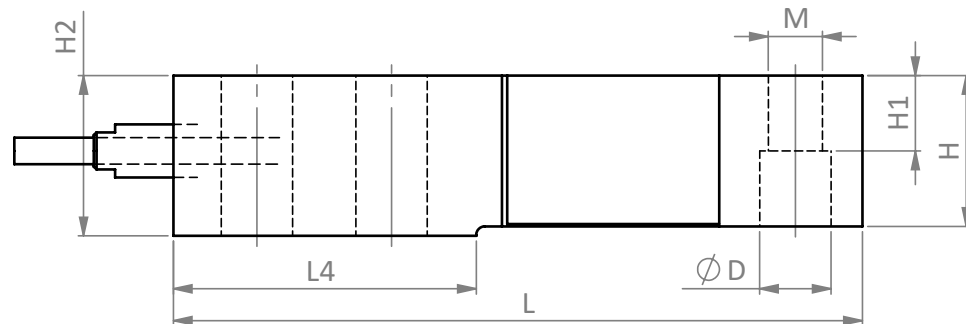

500kg – 5t Top View

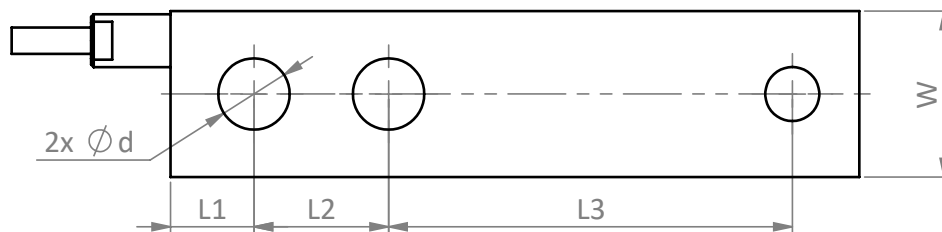

500kg – 5t Side View

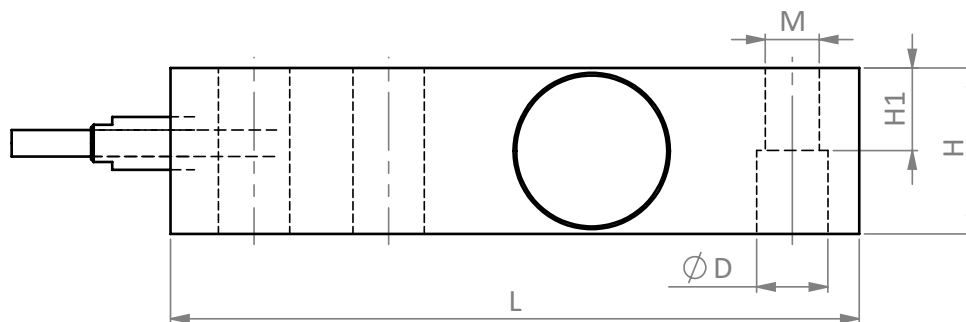

Dimension Capacity	L	L1	L2	L3	d	H	W	D	H1	H2	L4	M
0.25t	130.0	15.7	25.4	76.2	13.46	28.45	30.73	13.46	14.23	30.23	57.15	M12
0.5t-2t	130.0	15.7	25.4	76.2	13.46	31.32	31.32	13.46	15.75	-	-	M12
5t	171.5	19.1	38.1	95.2	20.65	36.83	36.83	20.65	18.85	-	-	M20

Specifications and dimensions are subject to change without notice and do not constitute any liability whatsoever.

Available Accessories

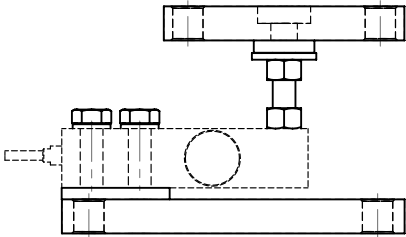
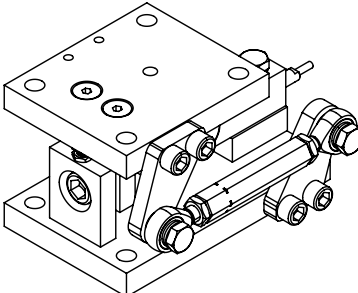
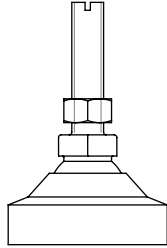
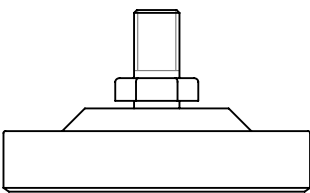
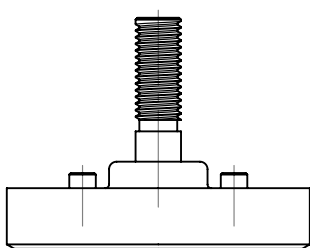
<p>BM-8-404-0.5-5t Mount</p> <ul style="list-style-type: none"> • Hardened stainless steel components • Compact construction • Using under heavy static load or slight dynamic load • Good ability against corrosive environments 	
<p>BM-8-902-0.25-5t Mount</p> <ul style="list-style-type: none"> • Complete mounting set with lift-off protection • Stainless steel • Using under heavy static load or slight dynamic load • Optional stay-rod assembly • Good ability against corrosive environments 	
<p>BJ-8-202-0.5-5t Foot</p> <ul style="list-style-type: none"> • Ø60-80 and height 92-105 mm • Stainless Steel • Adjustable height • Self-centering 	
<p>BJ-8-215-0.5-2t Foot</p> <ul style="list-style-type: none"> • Ø81 and height 48 mm • Easy installation • Adjustable height • Automatically centralized inside • Good ability of anti-side loading • Mainly used for platform scales, floor scales and other electronic weighing devices 	
<p>BJ-8-219-0.5-2t & BJ-8-220-0.5-2t Feet</p> <ul style="list-style-type: none"> • Ø80 and height 61mm (-219) / 56,5mm (-220) • Stainless steel • Easy installation • Automatically centralized inside • Good ability of anti-side loading • Mainly used for platform scales, floor scales and other electronic weighing devices 	
<p>HD-8-301-0.1-10t Spacer Plate</p> <ul style="list-style-type: none"> • Nickel Plated alloy steel • 3 different sizes for 3 capacity ranges • Easy installation 	